

PLEASE CHECK WWW.MOLEX.COM FOR LATEST PART INFORMATION

Part Number: [0674911037](#)
Status: **Active**
Overview: Serial ATA Products
Description: 1.27mm (.050") Pitch Serial ATA High Speed Header, Through Hole, Vertical, 7 Circuits, 0.38µm (15µ") Gold (Au) Selective Plating, with 2.35mm (.093") PC Tail Length, for 2.00mm (.079") PCB, Lead-free

Documents:

[3D Model](#) [Product Specification PS-67491-001 \(PDF\)](#)
[Drawing \(PDF\)](#) [RoHS Certificate of Compliance \(PDF\)](#)

General

Product Family	PCB Headers
Series	67491
Application	Board-to-Board, Wire-to-Board
Overview	Serial ATA Products
Product Name	Serial ATA

Physical

Breakaway	No
Circuits (Loaded)	7
Color - Resin	Black
Durability (mating cycles max)	50
First Mate / Last Break	Yes
Glow-Wire Compliant	No
Guide to Mating Part	No
Keying to Mating Part	Yes
Lock to Mating Part	Yes
Material - Plating Mating	Gold
Material - Plating Termination	Tin
Number of Rows	1
Orientation	Vertical
PC Tail Length (in)	0.093 In
PC Tail Length (mm)	2.35 mm
PCB Locator	Yes
PCB Retention	Yes
PCB Thickness Recommended (in)	0.080 In
PCB Thickness Recommended (mm)	2.00 mm
Packaging Type	Tray
Pitch - Mating Interface (in)	0.050 In
Pitch - Mating Interface (mm)	1.27 mm
Pitch - Term. Interface (in)	0.050 In
Pitch - Term. Interface (mm)	1.27 mm
Plating min: Mating (µin)	15
Plating min: Mating (µm)	0.38
Plating min: Termination (µin)	50.8
Plating min: Termination (µm)	1.27
Polarized to Mating Part	Yes
Polarized to PCB	Yes
Shrouded	No
Stackable	No
Surface Mount Compatible (SMC)	No
Temperature Range - Operating	-35°C to +85°C
Termination Interface: Style	Through Hole

Electrical

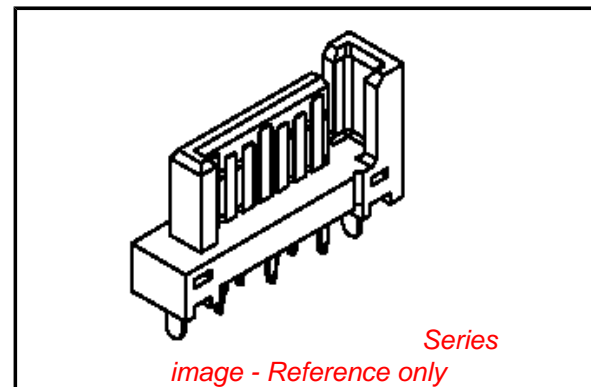

EU RoHS

ELV and RoHS Compliant
REACH SVHC
 Not Reviewed
Halogen-Free Status

China RoHS



Need more information on product environmental compliance?

Email productcompliance@molex.com
 For a multiple part number RoHS Certificate of Compliance, [click here](#)

Please visit the [Contact Us](#) section for any non-product compliance questions.

Search Parts in this Series

[67491Series](#)

Mates With

Serial ATA Signal Connector [67489](#) , [88755](#)

Current - Maximum per Contact
Voltage - Maximum

1.5A
15V DC

Solder Process Data

Lead-free Process Capability

Wave Capable (TH only)

Material Info

Reference - Drawing Numbers

Product Specification
Sales Drawing

PS-67491-001
SD-67491-002

This document was generated on 04/21/2010

PLEASE CHECK WWW.MOLEX.COM FOR LATEST PART INFORMATION

	10	9	8	7	6	
	P/N	CONTACT PLATING TYPE	"A"	"B"	PCB THICKNESS	SOLDERING PLATE
F	67491-0030	GOLD FLASH	2.05	2.40	1.60	TIN-LEAD
	67491-0031	0.76 MICRON GOLD PLATED				
	67491-0032	0.38 MICRON GOLD PLATED				
E	67491-0035	GOLD FLASH	2.35	2.40	2.00	
	67491-0036	0.76 MICRON GOLD PLATED				
	67491-0037	0.38 MICRON GOLD PLATED				
D	67491-0038	GOLD FLASH	3.00	3.20	2.40	
	67491-0039	0.76 MICRON GOLD PLATED				
	67491-0040	0.38 MICRON GOLD PLATED				
C	67491-1030	GOLD FLASH	2.05	2.40	1.60	PURE TIN
	67491-1031	0.76 MICRON GOLD PLATED				
	67491-1032	0.38 MICRON GOLD PLATED				
B	67491-1035	GOLD FLASH	2.35	2.40	2.00	
	67491-1036	0.76 MICRON GOLD PLATED				
	67491-1037	0.38 MICRON GOLD PLATED				
A	67491-1038	GOLD FLASH	3.00	3.20	2.40	
	67491-1039	0.76 MICRON GOLD PLATED				
	67491-1040	0.38 MICRON GOLD PLATED				

- NOTES:
- MATERIAL :
HOUSING: THERMAL PLASTIC, UL94V-0, COLOR: BLACK
TERMINAL/PEG: COPPER ALLOY
 - TERMINAL PLATING :
CONTACT AREA:
GOLD PLATED
SOLDER TAIL:
1.27 MOICRON MIN. TIN-LEAD OR TIN PLATED
UNDER PLATE:
1.27 MOICRON MIN. NICKEL PLATED
 - PEG PLATING:
1.27 MOICRON MIN. TIN-LEAD OR TIN PLATED
OVERALL 1.27 MOICRON MIN. TNICKEL UNDER PLATED
 - PACKAGING SPECIFICATION REFER TO PK-67491-001
 - PRODUCT SPECIFICATION REFER TO PS-67491-001
 - MATING PART: 67489
 - RECOMMENDED PROCESS: WAVE SOLDERING

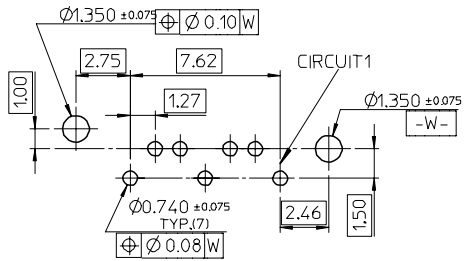
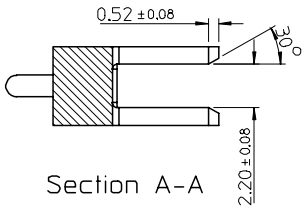
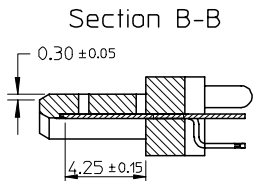
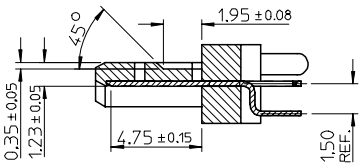
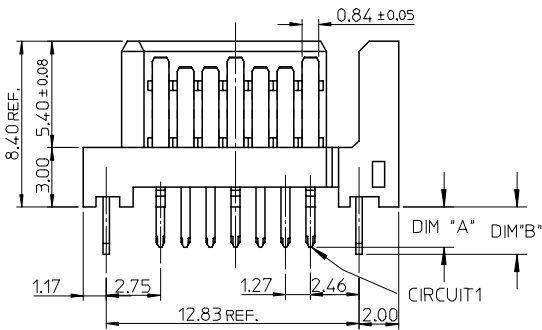
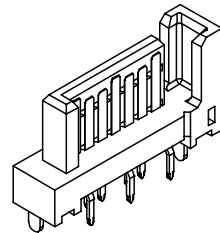
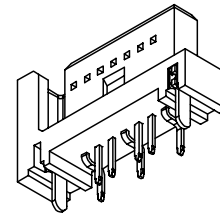
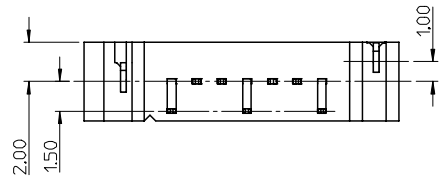
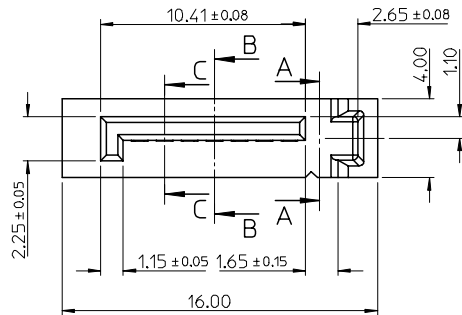
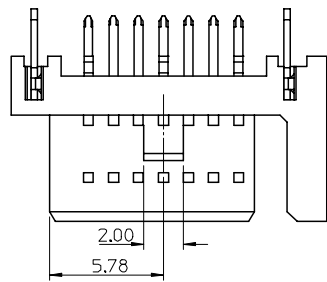

RECOMMENDED P.C.B. LAYOUT t=1.6mm OR 2.0mm

EC NO: SH2005-0049 DRWN:GRMA 2004/09/03 CHKD:GRATE M&004/09/07 APPR: YTYAP 2004/09/10	QUALITY SYMBOLS ▽ - 0 ▽ - 0	GENERAL TOLERANCES (UNLESS SPECIFIED)	SCALE 4:1	DESIGN UNITS METRIC	THIRD ANGLE PROJECTION	REVISE ON CAD ONLY																
		<table border="1"> <thead> <tr> <th></th> <th>mm</th> <th>INCH</th> </tr> </thead> <tbody> <tr> <td>4 PLACES</td> <td>± ---</td> <td>± ---</td> </tr> <tr> <td>3 PLACES</td> <td>± ---</td> <td>± ---</td> </tr> <tr> <td>2 PLACES</td> <td>± 0.15</td> <td>± ---</td> </tr> <tr> <td>1 PLACE</td> <td>± 0.25</td> <td>± ---</td> </tr> <tr> <td colspan="3">ANGULAR ± 3°</td> </tr> </tbody> </table>		mm	INCH	4 PLACES	± ---	± ---	3 PLACES	± ---	± ---	2 PLACES	± 0.15	± ---	1 PLACE	± 0.25	± ---	ANGULAR ± 3°			DIMENSION STYLE MM ONLY	TITLE 1.27MM HIGH SPEED SERIAL PLUG VERTICLE TYPE
	mm	INCH																				
4 PLACES	± ---	± ---																				
3 PLACES	± ---	± ---																				
2 PLACES	± 0.15	± ---																				
1 PLACE	± 0.25	± ---																				
ANGULAR ± 3°																						
REV DESCRIPTION	DRAFT WHERE APPLICABLE MUST REMAIN WITHIN DIMENSIONS	APPROVED BY ERIC	DATE '01/06/21	MATERIAL NO. SEE TABLE	DOCUMENT NO. SD-67491-002	SHEET NO. 1 OF 1																
		THIS DRAWING CONTAINS INFORMATION THAT IS PROPRIETARY TO MOLEX INCORPORATED AND SHOULD NOT BE USED WITHOUT WRITTEN PERMISSION																				

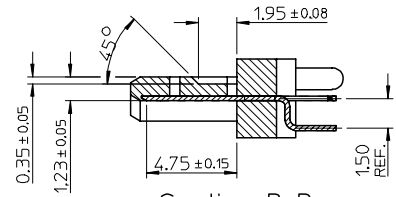

Section B-B

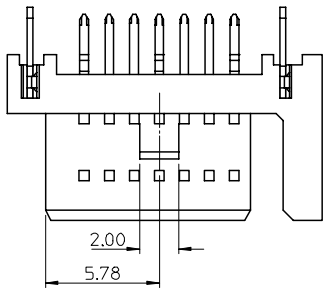

- NOTES:
- MATERIAL:
 - HOUSING: SEE TABLE, UL94V-0, COLOR: BLACK OR BULE (SEE P/N TABLE)
 - TERMINAL/PEG: COPPER ALLOY
 - TERMINAL PLATING :
 - CONTACT AREA: GOLD PLATED
 - SOLDER TAIL: 1.27 MICRON MIN. TIN PLATED
 - UNDER PLATE: 1.27 MICRON MIN. NICKEL PLATED
 - PEG PLATING:
 - 1.27 MICRON MIN. TIN PLATED
 - OVERALL 1.27 MICRON MIN. NICKEL UNDER PLATED
 - PACKAGING SPECIFICATION REFER TO PK-67491-001
 - PRODUCT SPECIFICATION REFER TO PS-67491-001
 - MATING PART: 67489
 - RECOMMENDED PROCESS: WAVE SOLDERING
 - PRODUCT COMPLIANT TO RoHS DIRECTIVE 2002/95/EC AND ELV DIRECTIVE 2000/53/EC"

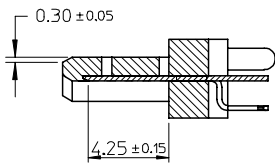

Section C-C

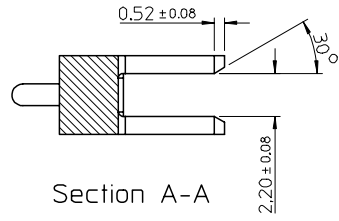
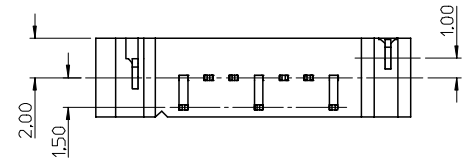
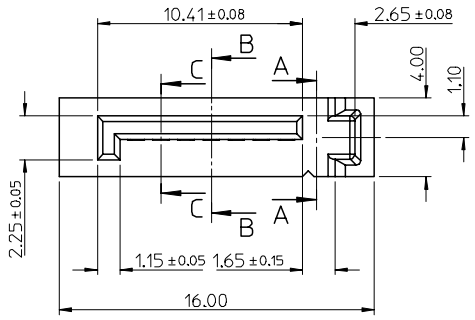

Section A-A

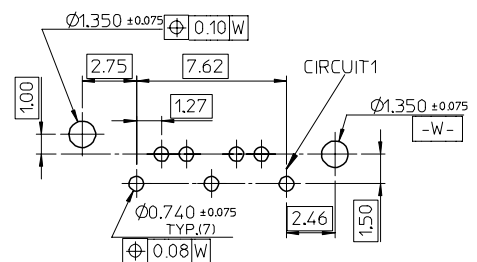
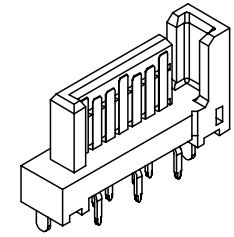
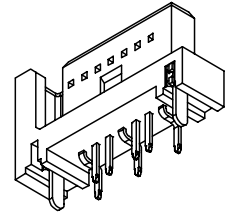
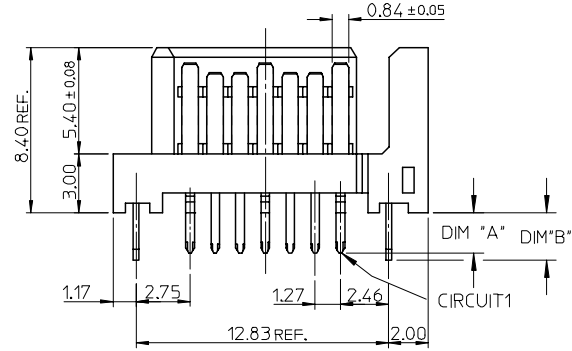

RECOMMENDED P.C.B. LAYOUT t=1.6mm OR 2.0mm

ADD PART NUMBER EC NO: SH2007-0134 DRWN: BCHENZ6 CHKD: JTIAN APPR: JNCHEN	QUALITY SYMBOLS ▽=0 ▽=0	GENERAL TOLERANCES (UNLESS SPECIFIED)		DIMENSION STYLE MM ONLY		SCALE 4:1	DESIGN UNITS METRIC	THIRD ANGLE PROJECTION			
		4 PLACES ± --- ± ---	3 PLACES ± --- ± ---	2 PLACES ± 0.15 ± ---	1 PLACE ± 0.25 ± ---	DRAWN BY DATE RICHARD '01/06/21		TITLE 1.27MM HIGH SPEED SERIAL PLUG VERTICAL TYPE			
		ANGULAR ± 3 °				CHECKED BY DATE VINCENT '01/06/21		MOLEX INCORPORATED			
		DRAFT WHERE APPLICABLE MUST REMAIN WITHIN DIMENSIONS				APPROVED BY DATE ERIC '01/06/21		MATERIAL NO. SEE SHEET2	DOCUMENT NO. SD-67491-002	SHEET NO. 1 OF 2	

	10	9	8	7	6	5	4	3	2	1			
	P/N	CONTACT PLATING TYPE	"A"	"B"	PCB THICKNESS	SOLDERING PLATE	COLOR	PLASTIC TYPE					
F	67491-1030	GOLD FLASH	2.05	2.40	1.60	PURE TIN	BLACK	THERMAL PLASTIC	▽F				
	67491-1031	0.76 MICRON GOLD PLATED											
	67491-1032	0.38 MICRON GOLD PLATED											
67491-1035	GOLD FLASH												
67491-1036	0.76 MICRON GOLD PLATED												
67491-1037	0.38 MICRON GOLD PLATED												
E	67491-1038	GOLD FLASH	3.00	3.20	2.40		PURE TIN	BLACK			THERMAL PLASTIC	▽F	
	67491-1039	0.76 MICRON GOLD PLATED											
	67491-1040	0.38 MICRON GOLD PLATED											
67491-2030	GOLD FLASH												
67491-2031	0.76 MICRON GOLD PLATED												
67491-2032	0.38 MICRON GOLD PLATED												
D	67491-2035	GOLD FLASH	2.05	2.40	1.60	PURE TIN	BLUE PENTONE NO.293C ΔE<3	THERMAL PLASTIC	▽F				
	67491-2036	0.76 MICRON GOLD PLATED											
	67491-2037	0.38 MICRON GOLD PLATED											
67491-2038	GOLD FLASH												
67491-2039	0.76 MICRON GOLD PLATED												
67491-2040	0.38 MICRON GOLD PLATED												
C	67491-1130	GOLD FLASH	2.05	2.40	1.60	PURE TIN	BLACK	HIGH TEMPERATURE THERMAL PLASTIC			▽F		
	67491-1131	0.76 MICRON GOLD PLATED											
	67491-1132	0.38 MICRON GOLD PLATED											
	67491-1135	GOLD FLASH											
	67491-1136	0.76 MICRON GOLD PLATED											
	67491-1137	0.38 MICRON GOLD PLATED											
A	67491-1138	GOLD FLASH	3.00	3.20	2.40	PURE TIN	BLACK	HIGH TEMPERATURE THERMAL PLASTIC	▽F				
	67491-1139	0.76 MICRON GOLD PLATED											
	67491-1140	0.38 MICRON GOLD PLATED											

B										
---	--	--	--	--	--	--	--	--	--	--

A	ADD PART NUMBER EC NO: SH2007-0134 DRWN: B. CHENZ 2006/09/01 CHKD: J. TAN 2006/09/01 APPR: J. CHEN 2006/09/08	REV	DESCRIPTION	QUALITY SYMBOLS	GENERAL TOLERANCES (UNLESS SPECIFIED)	DIMENSION STYLE		SCALE	DESIGN UNITS	THIRD ANGLE PROJECTION
				▽=0 ▽C=0		MM ONLY	4:1	METRIC	☉	
						mm	INCH	DRAWN BY	DATE	TITLE
						4 PLACES ± --- ± ---	RICHARD	'01/06/21	1.27MM HIGH SPEED SERIAL PLUG VERTICAL TYPE	
	3 PLACES ± --- ± ---	CHECKED BY	DATE							
	2 PLACES ± 0.15 ± ---	VINCENT	'01/06/21							
	1 PLACE ± 0.25 ± ---	APPROVED BY	DATE							
	ANGULAR ± 3 °	ERIC	'01/06/21							
		MATERIAL NO.	DOCUMENT NO.	SHEET NO.						
	DRAFT WHERE APPLICABLE MUST REMAIN WITHIN DIMENSIONS	SEE TABLE	SD-67491-002	2 OF 2						
		SIZE	THIS DRAWING CONTAINS INFORMATION THAT IS PROPRIETARY TO MOLEX INCORPORATED AND SHOULD NOT BE USED WITHOUT WRITTEN PERMISSION							
		A3								